



# Axial Fan Series



## Technische Beschreibung / Technical description

### Baugrößen und Leistungsbereiche

Lti Axialventilatoren werden in den Baugrößen von 315 mm bis 1600 mm Flügeldurchmesser gefertigt. Es lassen sich Luftmengen bis 360.000 m<sup>3</sup>/h bei statischen Drücken bis zu 1.500 Pa erzielen.

### Gehäuse

Das Gehäuse und die Motorbefestigung bestehen aus verzinktem Stahl. Die Flansche an beiden Enden sind angedrückt und gelocht nach DIN 24154, Reihe 3. Der Klemmenkasten ist außen am Gehäuse angebracht. Zur Drehrichtungskontrolle ist ein Sichtloch im Gehäuse vorgesehen.

### Laufräder

Die Laufräder (Nabe und Flügel) werden aus Alu-Guss-Legierung hergestellt. Alle drehenden Aluminiumteile werden zur Qualitätssicherung vor dem Zusammenbau mit Röntgenstrahlen durchleuchtet. Die Laufradschaufeln mit aerodynamischem Profil garantieren hohe Wirkungsgrade und sind geräuscharm.

Die Nabenkonstruktion erlaubt eine stufenlose Verstellung des Schaufelwinkels im Stillstand, um den optimalen Betriebspunkt zu erreichen. Von Baugröße 315 bis 500 sind die Axialventilatoren mit 7 Laufradschaufeln ausgestattet. Ab Baugröße 560 bietet Lti zusätzlich zur Standardversion mit 9 Flügeln (560-800), 10 Flügeln (900-1000) oder 14 Flügeln (1250) Versionen mit variabler Schaufelzahl an. Dadurch wird der Leistungsbereich zusätzlich vergrößert.

In den Kennlinien wird  $PL_{max}$  angegeben, die maximale Aufnahmeleistung des Laufrades bezogen auf den eingestellten Flügelwinkel.

### Motoren

Lti verwendet 400 V/50 Hz Drehstrom-Motoren gemäß IEC-Standard 34-1. Die eingebauten Motoren eignen sich für Fördermitteltemperaturen von -20 °C bis +40 °C. Motorschutz durch eingebaute Kaltleiter. Schutzart IP 55, Iso-Klasse F. Andere Fördermitteltemperaturen, Schutzarten oder Iso-Klassen sind auf Anfrage erhältlich. Das Standardprogramm umfasst ein- und zweipolige Motoren (schaltbar). Die eingebauten Motoren sind

### Fan sizes and duties

Lti axial fans are offered in sizes from 315 mm up to 1600 mm impeller diameter. Air volumes of up to 360.000 m<sup>3</sup>/h and static pressure drops up to 1.500 Pa can be achieved.

### Casing

The casing and motor fixation is manufactured from galvanized mild steel. With pressed flanges at both ends, drilled in accordance with DIN 24154, series 3. The terminal fitted on the outside of the casing, access panel will be provided for ease for maintenance or checking the direction of rotation. Lubrication points will be extended to casing and drain plug fitted to the casing

### Impellers

The impellers (hub and blades) are manufactured from die-cast aluminium alloy. All rotating aluminium parts are x-rayed before assembly for quality assurance. The impeller blades have an aerodynamic profile to guarantee high efficiencies and a low noise level.

The hub design allows adjustment of the blade angle during assembly of the fan in the factory, in order to achieve the optimum working point.

The pitch angle of the blades are readily and accurately adjustable.

In the performance curves  $PL_{max}$  is indicated, the maximum absorbed power of the impeller, related to the relevant blade angle setting.

### Motors

Lti uses 400 V/50 Hz three phase motors in accordance with IEC standard 34-1. The motors are suitable for medium temperatures from -20 °C up to +40 °C and are equipped with cold conductors for motor protection. Protection class IP 55, insulation class F. Other medium temperatures, protection classes or Iso-classes are available on request. The standard motor range includes single and two speed motors (switching between poles). The motors are not speed controllable by voltage. Speed control is possible with commercially available frequency inverters.

## Technische Beschreibung / Technical description

### Einbaulage und Strömungsrichtung

Lti Axial ventilatoren AR lassen sich in unterschiedlichen Lagen problemlos einbauen. Wird bei der Bestellung nichts abweichendes angegeben, erfolgt die Lieferung in Strömungsrichtung „S“, wie nachfolgend abgebildet. Drehrichtungs- und Luftrichtungspfeile sind außen am Gehäuse angebracht. Bei größeren Motorenleistungen (Richtwert ab IEC 160 mit 11 kW Leistung) muss eine von Strömungsrichtung „S“ abweichende Einbaulage bei der Bestellung unbedingt angegeben werden, da die Motorlager dann einer höheren Beanspruchung unterliegen und dies berücksichtigt werden muss.

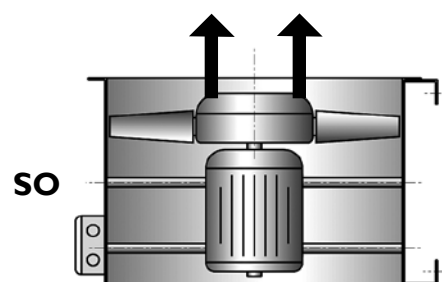
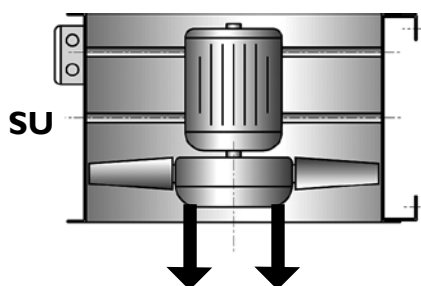
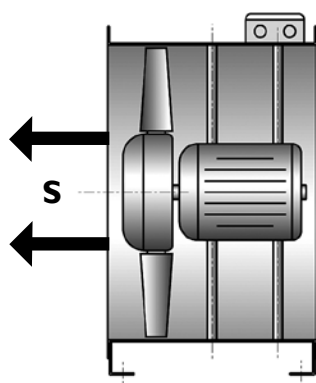

### Mounting position and airflow direction

Lti axial fans AR can be installed in different mounting positions. Should there be no different information in your order, the fans will be supplied in airflow direction “S”, see pictures below. You will find arrows indicating the direction of rotation and airflow direction at the outside of the casing. For bigger motor powers (guideline: from IEC 160, 11 kW) it is important to inform us with your order in case the fans are to be installed in a different airflow direction than “S”, as the motor bearings then are subject to a higher stress which we have to take into account.

## Technische Beschreibung / Technical description

### Zubehör

Lti bietet ein umfangreiches Zubehörprogramm an, wie z.B.:

- Schutzgitter
- Montagefüße (horizontale Montage) oder Montagepratzen (vertikale Montage)
- Gegenflansche
- Flexible Verbindungsstutzen
- Einströmdüsen
- Selbsttätige Rückschlagklappen
- Schwingungsdämpfer
- Reparaturschalter für ein- oder zweitourige Motoren

### Accessories

Lti offers a wide range of accessories, such as:

- protection guards
- mounting feet (horizontal installation) or mounting brackets (vertical installation)
- counter flanges
- flexible connections
- inlet cones
- automatic shutters
- anti vibration mounts
- isolators for single or two-speed motors

### Typenschlüssel / Fan code

AR - 450 - 2

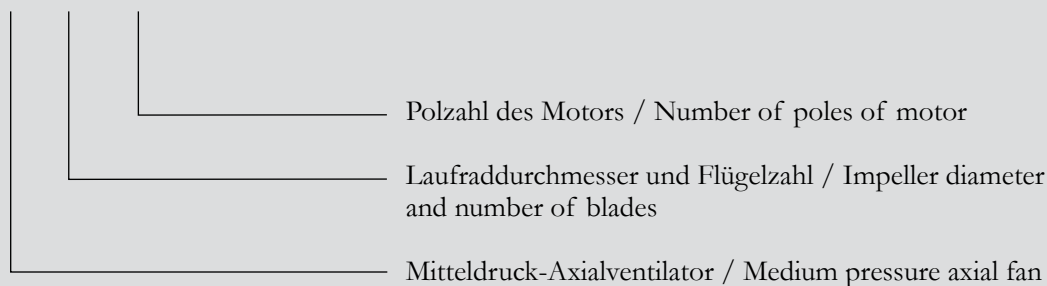

## Useful information

### Ventilatorauslegung

Der gewählte Betriebspunkt muss auf oder unterhalb der Kennlinie für die gewählte Flügelstellung liegen. Bei Auslegung außerhalb des Kennlinienbereiches besteht die Gefahr des Abreißen der Ventilator Kennlinie, der Ventilator pumpt. Dies hat zur Folge, dass die mechanische Belastung auf das Laufrad so groß werden kann, dass das Laufrad zerstört wird. Um die größtmögliche Betriebssicherheit gewährleisten zu können, haben wir die Motoren nach dem größtmöglichen Kraftbedarf innerhalb der Flügelwinkelkennlinie zugeordnet. Damit wird eine etwaige Motorüberlastung ausgeschlossen. Liegt der Betriebspunkt in einem Bereich mit hohem Wirkungsgrad, empfehlen wir, die benötigte Motorleistung nach dem Betriebspunkt zu berechnen. Damit wird eine eventuelle Überdimensionierung der Motoren vermieden.

$$PL \text{ [kW]} = \frac{V \text{ [m}^3\text{/s]} \times \Delta p_t \text{ [Pa]}}{\eta \text{ [\%]} \times 10}$$

### Ventilatoreinbau

Bitte beachten Sie:

- Bei frei ansaugenden und/oder frei ausblasenden Ventilatoren muss saug- und/oder druckseitig ein Mindestabstand von 1,5 x Ventilator Durchmesser zum nächsten Bauteil gegeben sein. Die Saugseite sollte mit einer Einströmdüse versehen werden, um eine gleichmäßige Anströmung zu gewährleisten.
- Bei Ventilatoren, welche in eine Rohrleitung eingebaut werden, ist darauf zu achten, dass saug- und druckseitige Zubehör- bzw. Anschlussteile (Bögen, Umlenkungen, Schalldämpfer, Klappen) ebenfalls mit dem notwendigen Abstand eingebaut werden, um Leistungsverluste zu vermeiden (siehe Abbildungen unten).

### Fan selection

The chosen operating point of the fan has to be on or under the curve for the selected blade angle. If a fan is selected outside the performance curve, the fan might start pumping, which could increase the mechanical stress on the impeller so much that it would be destroyed. In order to assure the highest possible security for operation of the fan, we have selected the motors depending on the highest possible power consumption of one whole blade angle setting, to avoid a possible motor overloading.

If the operating point of the fan is in an area of the performance curve with a high efficiency, we recommend to calculate the required motor power depending on the actual operating point. A possible over-dimensioning of the motor can be avoided.

### Fan installation

Please note:

- In case fans are installed with free inlet or free outlet, a minimum distance of 1,5 times fan diameter to the next constructional element or component has to be observed. The inlet side should be equipped with an inlet cone to ensure a uniform incoming airflow.
- In case fans are installed in a duct, observe minimum distances (see drawings below) to accessories or connecting parts (duct bends, silencers, shutters) at the inlet or outlet side of the fan to avoid performance losses.

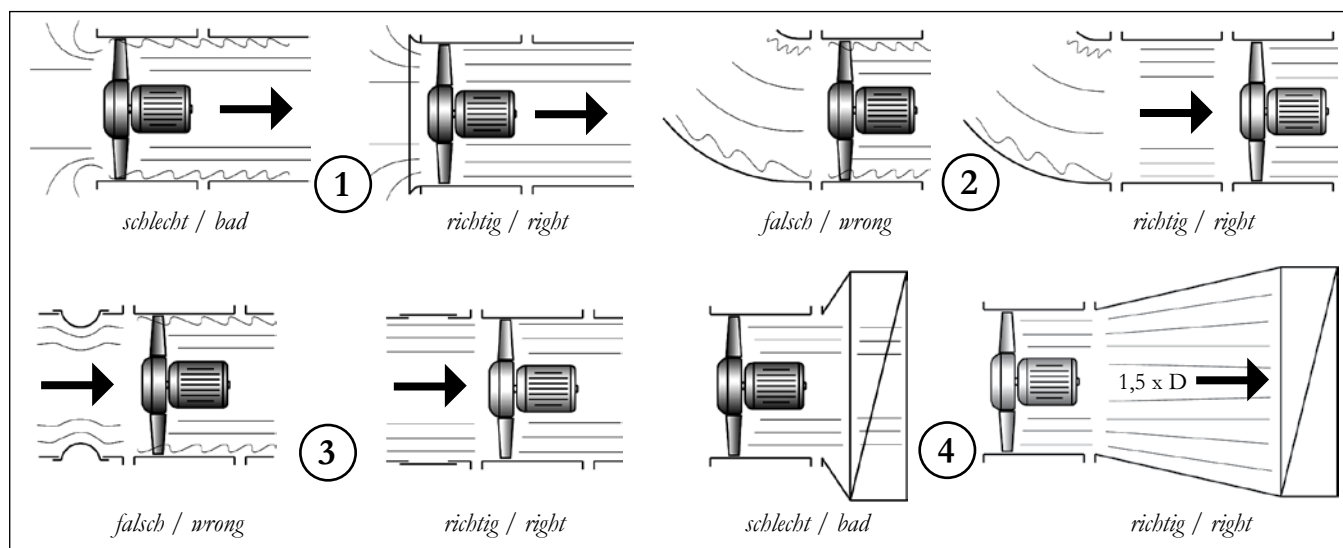

Robrlänge min. 1x Ø / Duct length min. 1x Ø

# Fan installation with accessories

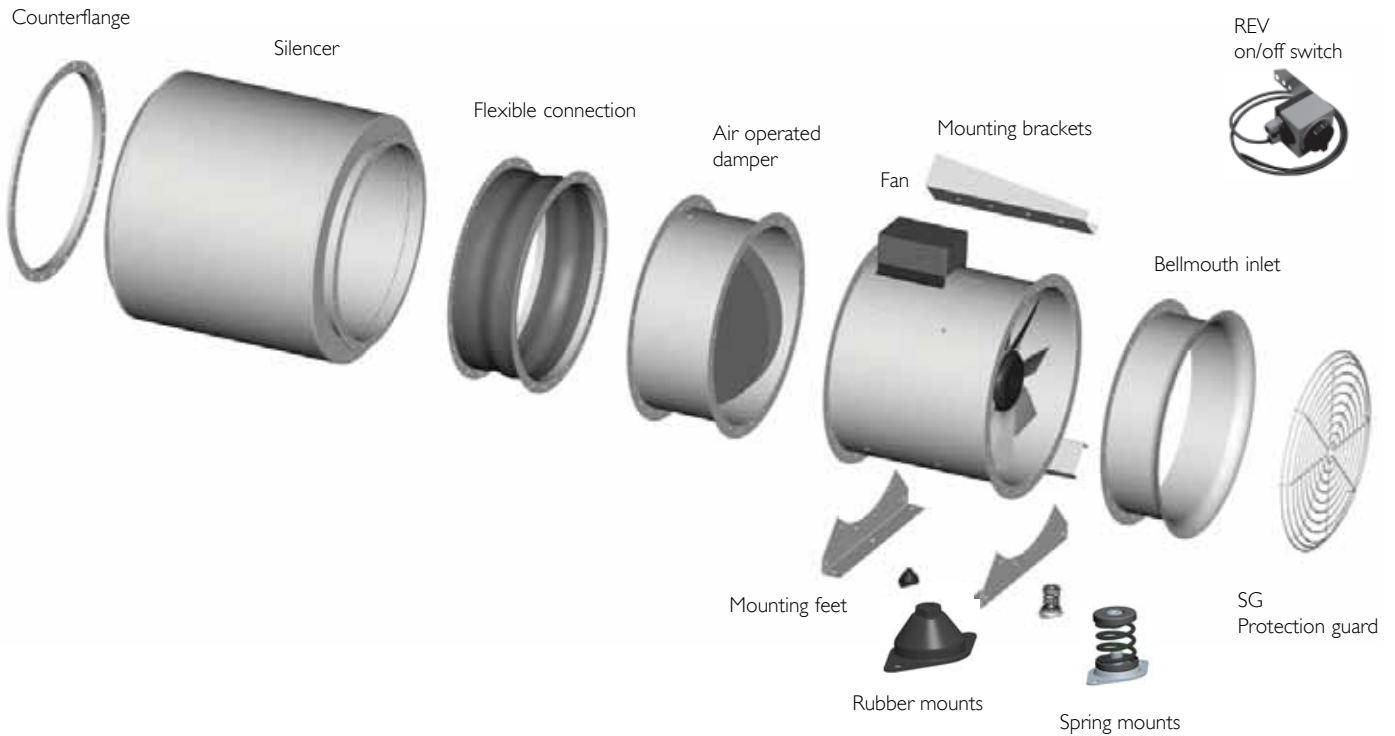

## Certificate and Approval on high temperature test



# AR-1000-4

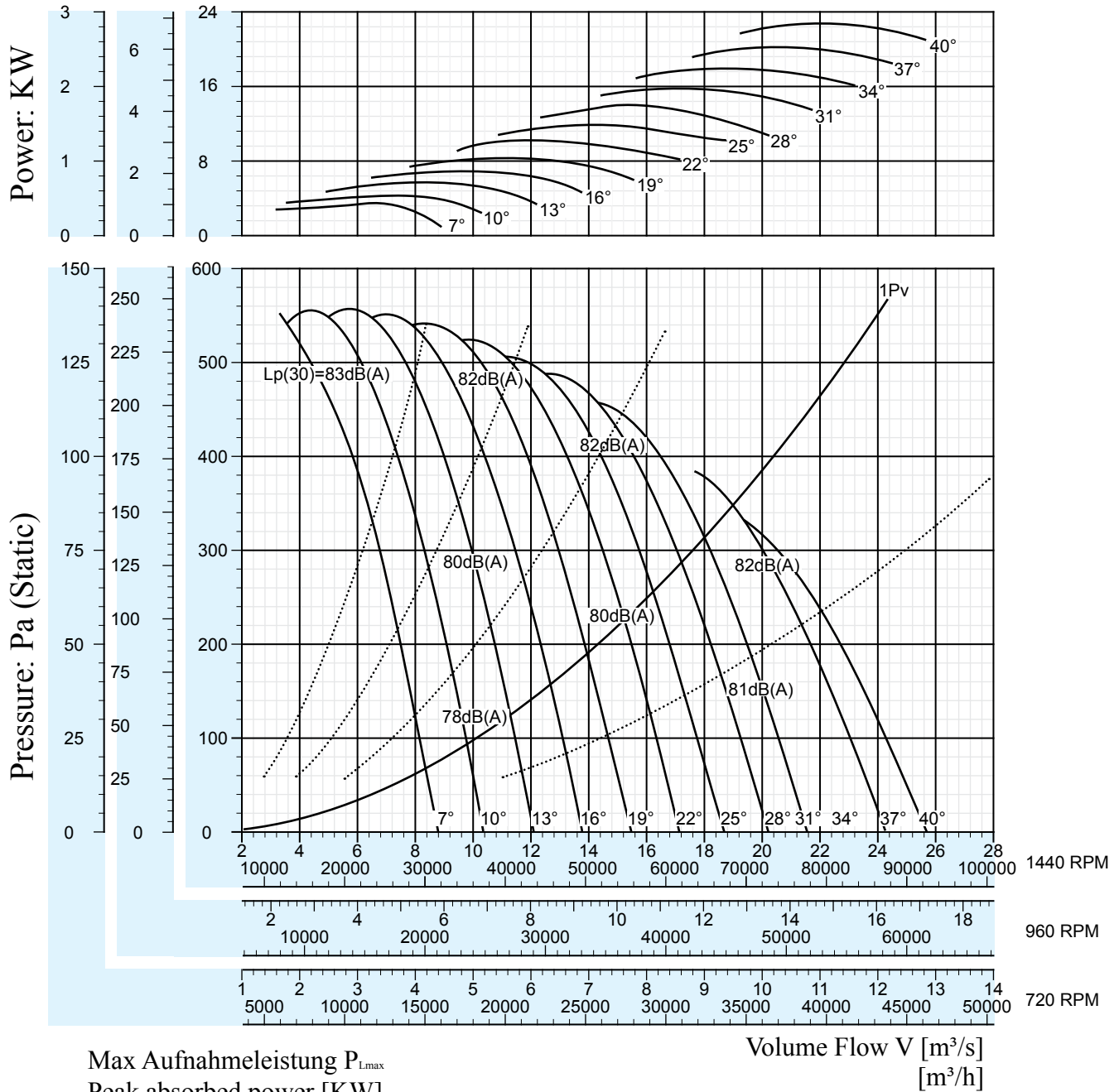

Max Aufnahmeleistung  $P_{L,max}$   
Peak absorbed power [KW]

n [min <sup>-1</sup> ]	Pitch Angle	7°	10°	13°	16°	19°	22°	25°	28°	31°	34°	37°	40°
720	Peak KW	0.409	0.543	0.695	0.860	1.05	1.28	1.47	1.75	1.97	2.22	2.51	2.82
960		0.970	1.29	1.65	2.04	2.50	3.03	3.48	4.14	4.68	5.27	5.95	6.69
1440		3.27	4.35	5.56	6.88	8.42	10.2	11.7	14.0	15.8	17.8	20.1	22.6

Sound Pressure Level  $L_w$  [dB]

n [min <sup>-1</sup> ]	Pitch Angle	7°	10°	13°	16°	19°	22°	25°	28°	31°	34°	37°	40°
720	dB (A)	62	59	60	58	61	60	59	60	61	60	61	61
960		68	65	66	64	67	66	65	66	67	66	67	67
1440		77	74	75	73	76	75	74	75	76	75	76	76



# AR-1000-7

Sound level are base on 1440 RPM Speed

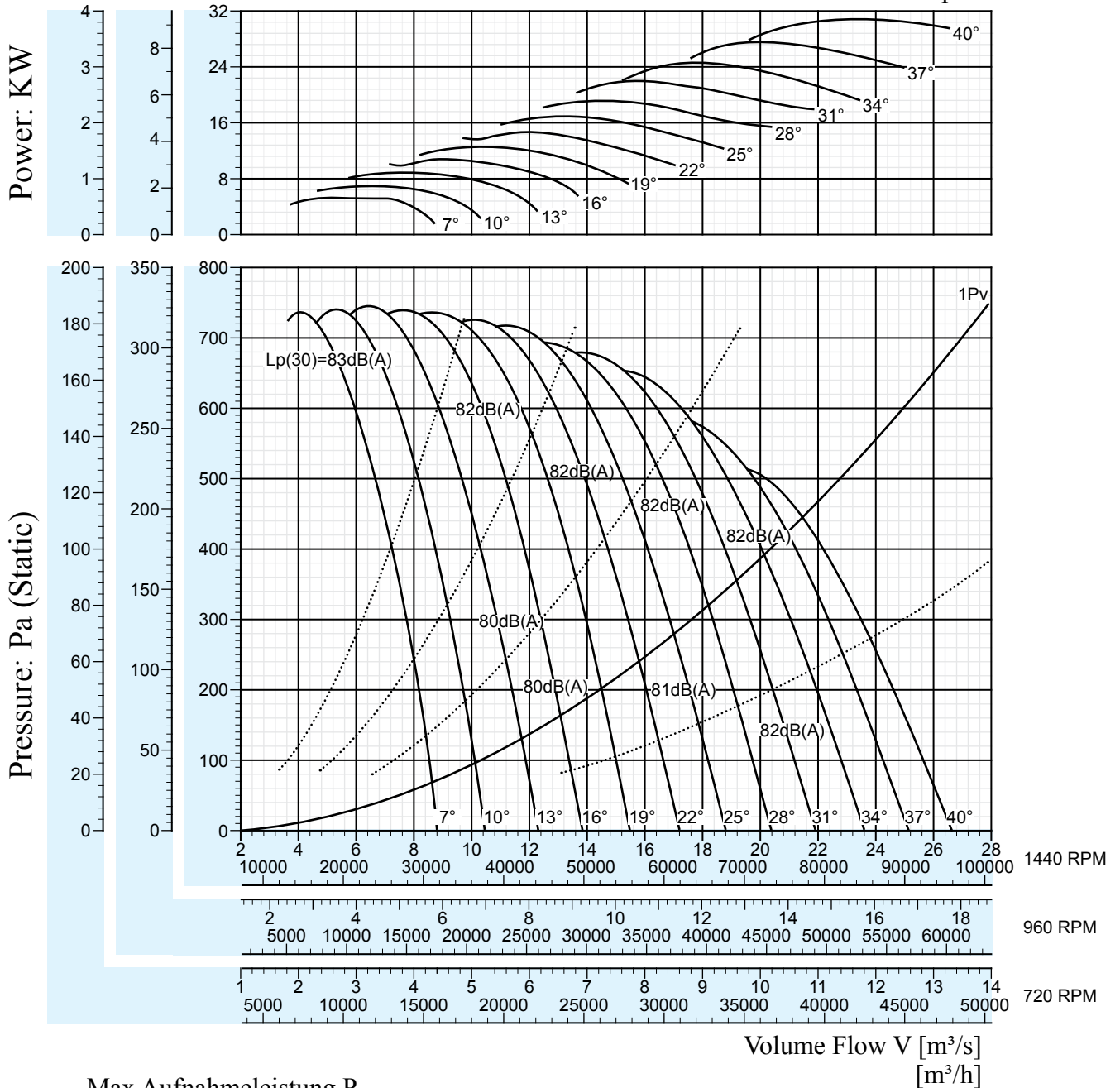

Max Aufnahmeleistung  $P_{L,max}$   
Peak absorbed power [KW]

Speed RPM	Pitch Angle	7°	10°	13°	16°	19°	22°	25°	28°	31°	34°	37°	40°
720	Peak KW	0.665	0.867	1.09	1.32	1.56	1.83	2.10	2.37	2.72	3.03	3.41	3.82
960		1.58	2.06	2.57	3.14	3.70	4.33	4.97	5.61	6.46	7.19	8.08	9.04
1440		5.32	6.94	8.68	10.6	12.5	14.6	16.8	18.9	21.8	24.3	27.3	30.5



# AR-1000-11

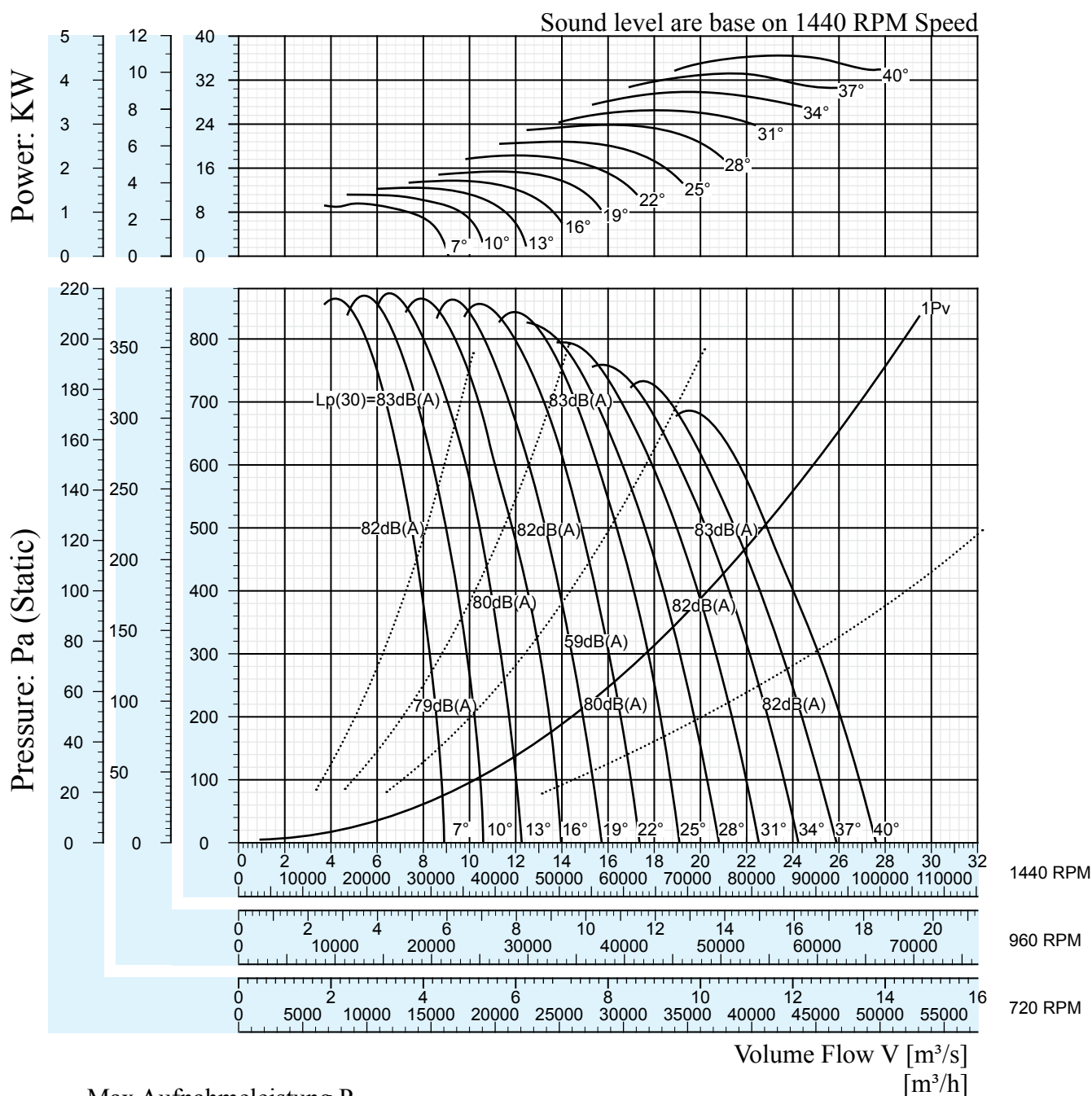

Max Aufnahmeleistung  $P_{L,max}$   
Peak absorbed power [KW]

Speed RPM	Pitch Angle	7°	10°	13°	16°	19°	22°	25°	28°	31°	34°	37°	40°
720	Peak KW	1.19	1.39	1.58	1.66	1.93	2.32	2.61	2.97	3.31	3.71	4.09	4.52
960		2.83	3.28	3.75	3.93	4.58	5.49	6.19	7.04	7.85	8.79	9.70	10.7
1440		9.55	11.1	12.7	13.3	15.5	18.5	20.9	23.8	26.5	29.7	32.7	36.1

# AR-1067-4

Sound level are base on 1440 RPM Speed

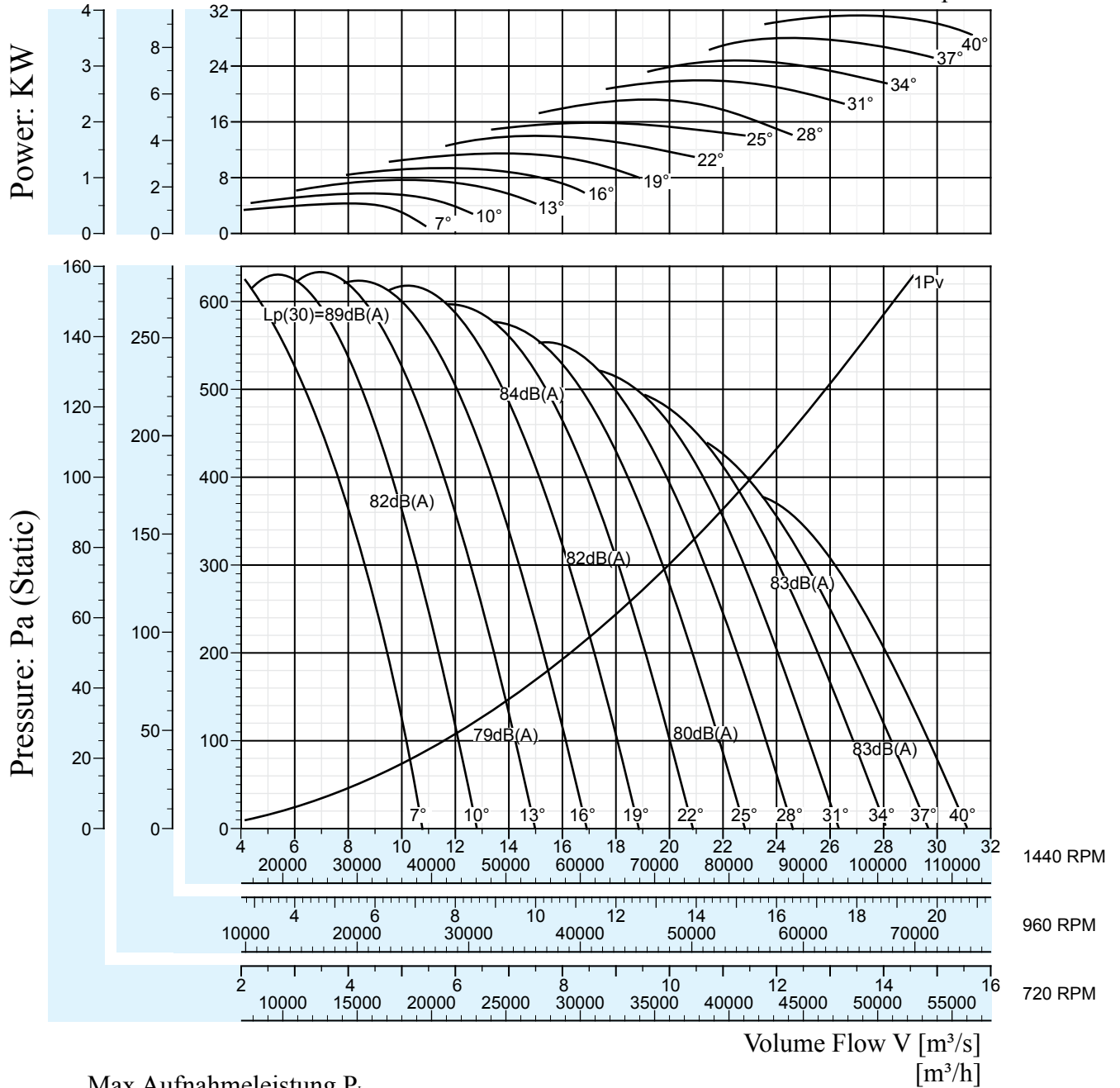

Max Aufnahmeleistung  $P_{Lmax}$   
Peak absorbed power [KW]

Speed RPM	Pitch Angle	7°	10°	13°	16°	19°	22°	25°	28°	31°	34°	37°	40°
720	Peak KW	0.566	0.751	0.962	1.19	1.46	1.77	2.03	2.42	2.73	3.07	3.47	3.90
960		1.34	1.78	2.28	2.82	3.45	4.18	4.81	5.72	6.47	7.28	8.23	9.25
1440		4.53	6.01	7.69	9.51	11.6	14.1	16.2	19.3	21.8	24.6	27.8	31.2

# AR-1067-7

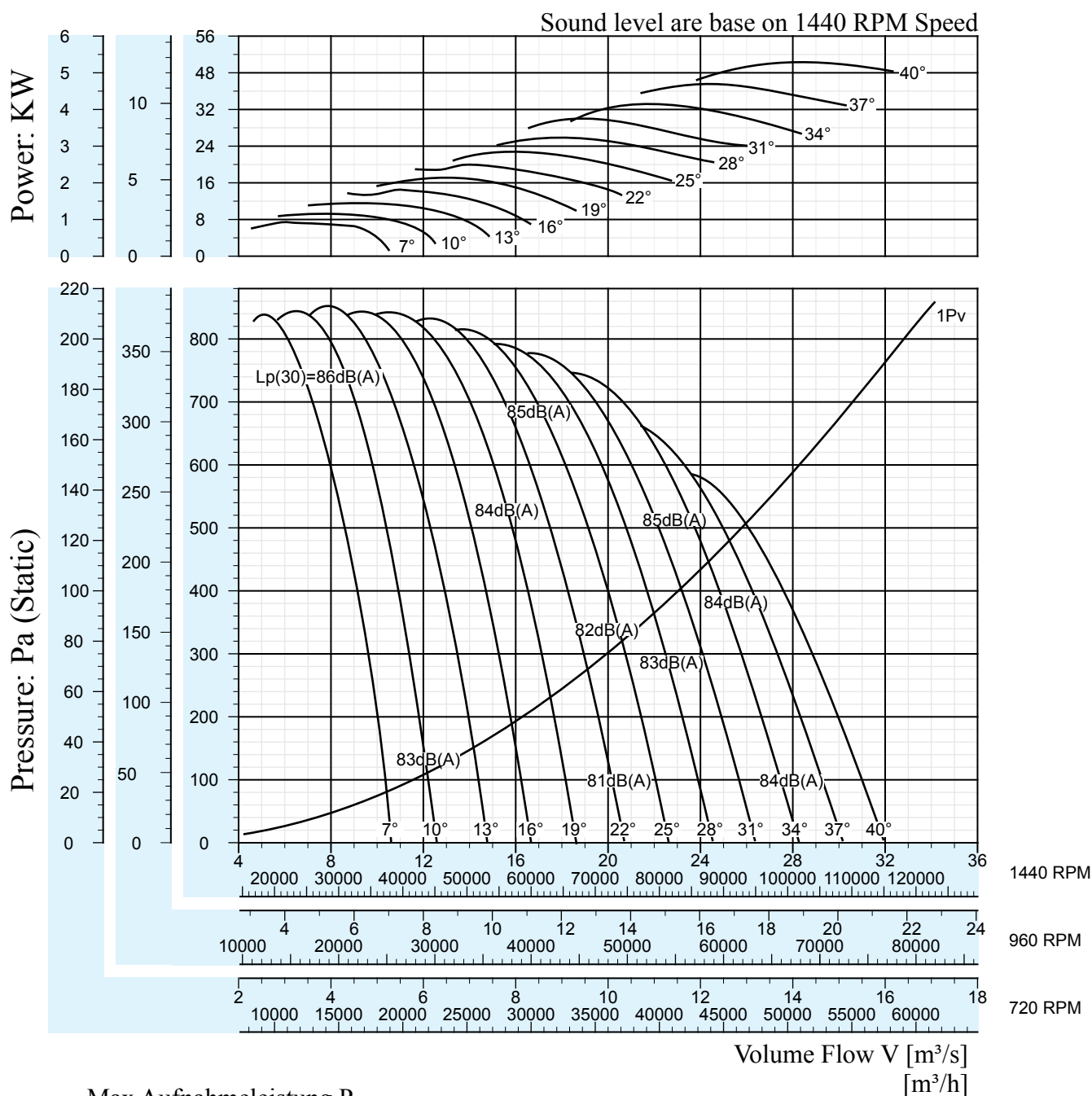

Max Aufnahmeleistung  $P_{L,max}$   
Peak absorbed power [KW]

Speed RPM	Pitch Angle	7°	10°	13°	16°	19°	22°	25°	28°	31°	34°	37°	40°
720	Peak KW	0.919	1.20	1.50	1.83	2.16	2.53	2.90	3.27	3.77	4.19	4.72	5.28
960		2.18	2.84	3.56	4.34	5.12	5.99	6.87	7.76	8.93	9.94	11.2	12.5
1440		7.36	9.60	12.0	14.7	17.3	20.2	23.2	26.2	30.1	33.6	37.7	42.2

# AR-1067-11

Sound level are base on 1440 RPM Speed

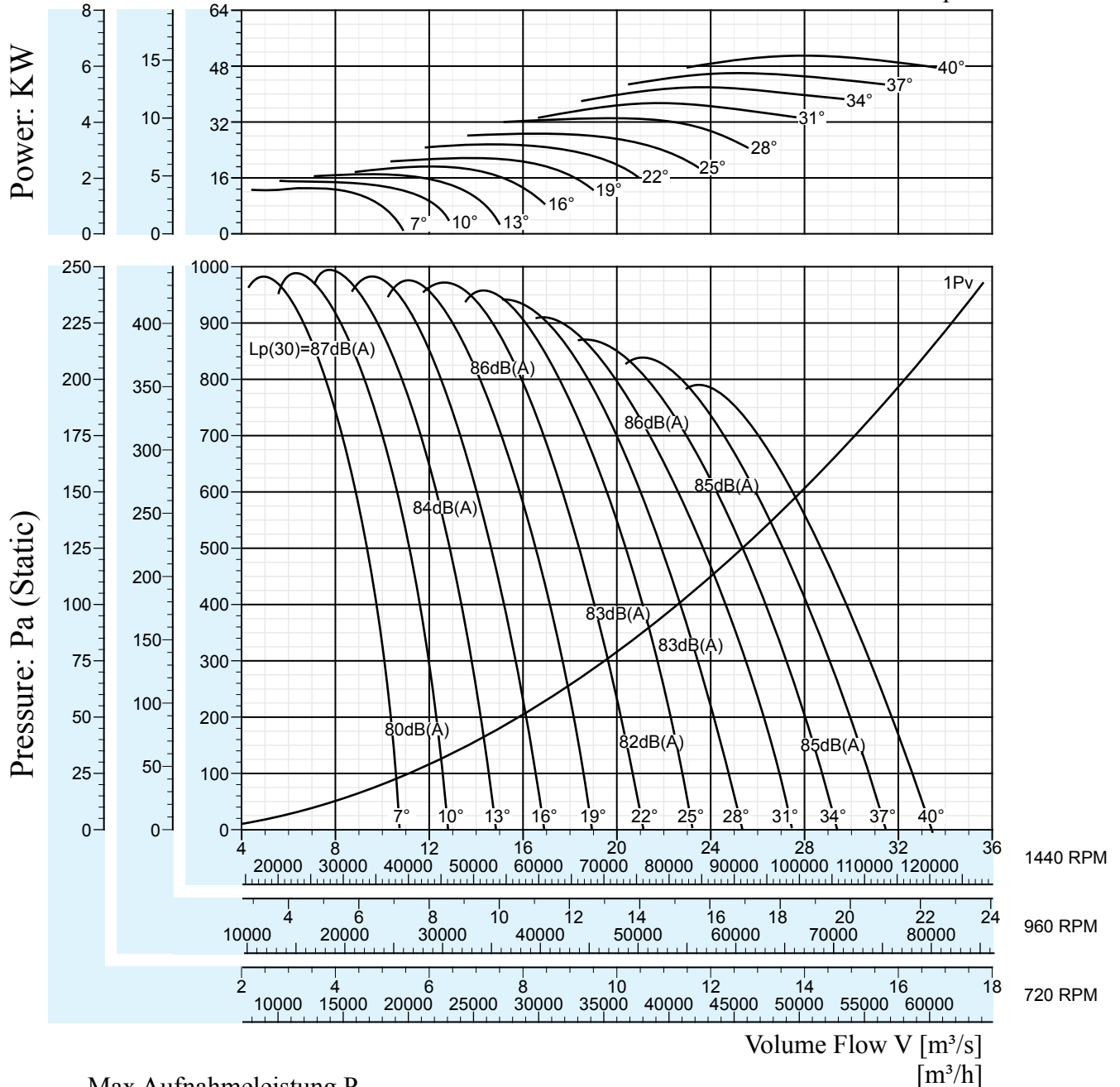

Max Aufnahmeleistung  $P_{Lmax}$   
Peak absorbed power [KW]

Speed RPM	Pitch Angle	7°	10°	13°	16°	19°	22°	25°	28°	31°	34°	37°	40°
720	Peak KW	1.65	1.92	2.19	2.29	2.67	3.20	3.61	4.11	4.58	5.13	5.66	6.25
960		3.91	4.54	5.19	5.43	6.34	7.60	8.56	9.73	10.9	12.2	13.4	14.8
1440		13.2	15.3	17.5	18.3	21.4	25.6	28.9	32.9	36.6	41.0	45.3	50.0

# AR-1250-4

Sound level are base on 1440 RPM Speed

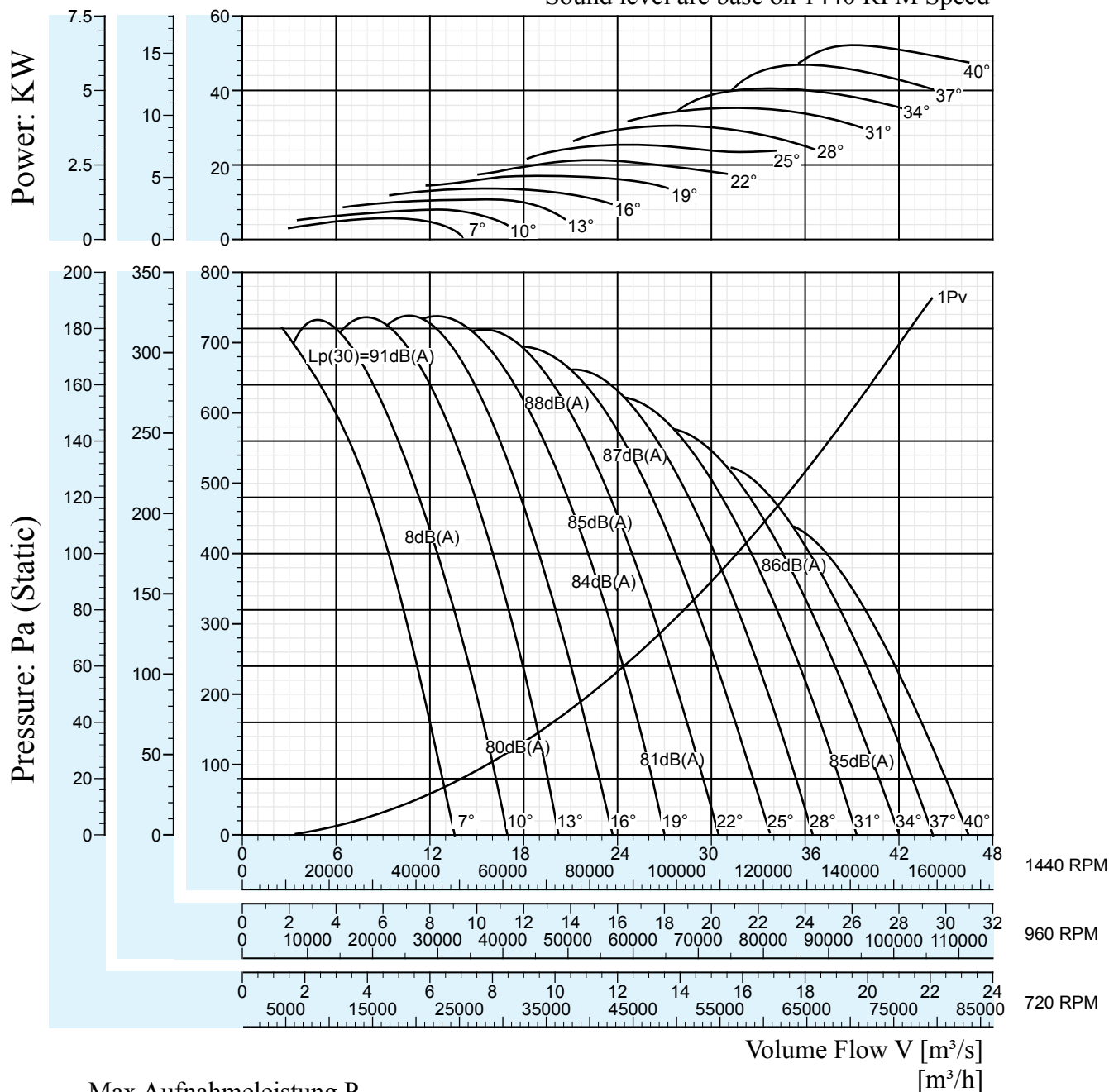

Max Aufnahmeleistung  $P_{Lmax}$   
Peak absorbed power [KW]

Speed RPM	Pitch Angle	7°	10°	13°	16°	19°	22°	25°	28°	31°	34°	37°	40°
720	Peak KW	0.723	0.973	1.32	1.70	2.17	2.66	3.17	3.76	4.34	5.01	5.81	6.47
960		1.71	2.31	3.14	4.04	5.14	6.30	7.51	8.91	10.3	11.9	13.8	15.3
1440		5.79	7.79	10.6	13.6	17.3	21.3	25.3	30.1	34.8	40.1	46.5	51.8

# AR-1250-7

Sound level are base on 1440 RPM Speed

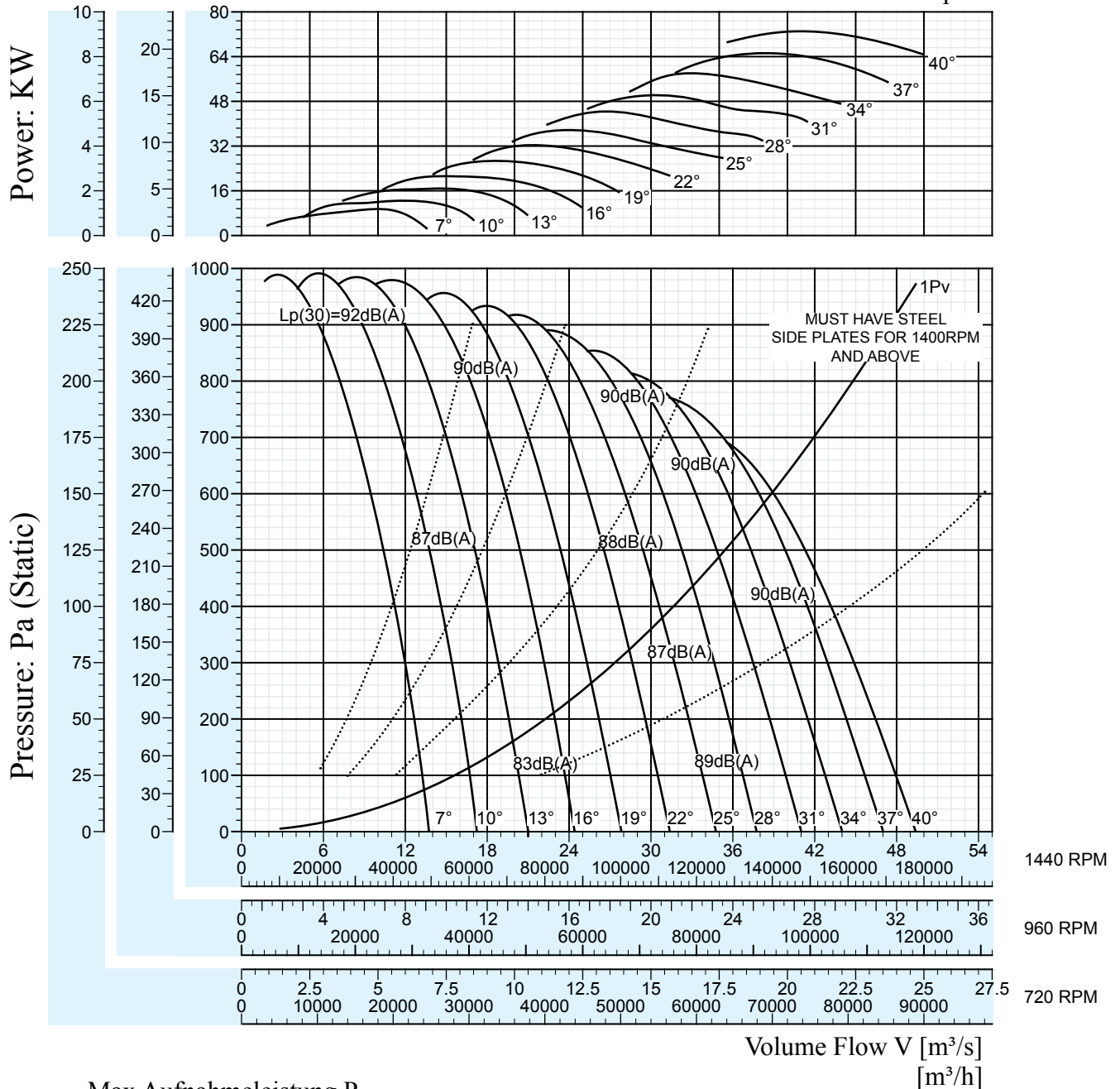

Max Aufnahmeleistung  $P_{L,max}$   
Peak absorbed power [KW]

Speed RPM	Pitch Angle	7°	10°	13°	16°	19°	22°	25°	28°	31°	34°	37°	40°
720	Peak KW	1.11	1.51	2.04	2.63	3.33	3.99	4.69	5.47	6.25	7.15	8.10	9.13
960		2.63	3.57	4.83	6.22	7.89	9.45	11.1	13.0	14.0	16.9	9.2	21.6
1440		8.87	12.1	16.3	21.0	26.6	31.9	37.5	43.0	50.0	57.2	64.8	73.0

# AR-1250-11

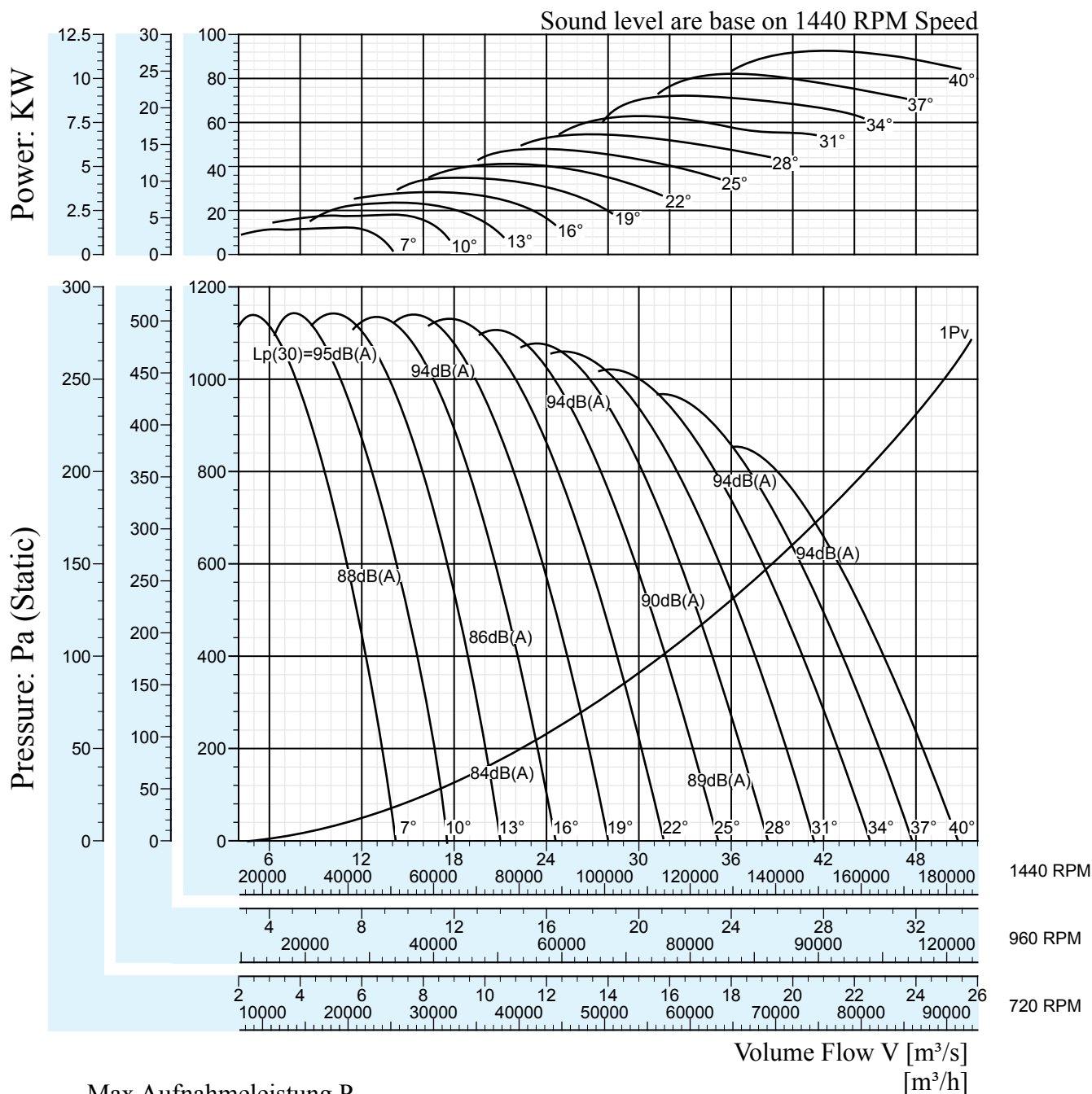

Max Aufnahmeleistung  $P_{Lmax}$   
Peak absorbed power [KW]

Speed RPM	Pitch Angle	7°	10°	13°	16°	19°	22°	25°	28°	31°	34°	37°	40°
720	Peak KW	1.56	2.21	2.82	3.54	4.32	5.14	6.02	6.83	7.86	8.93	10.1	11.3
960		3.70	5.23	6.68	8.40	10.2	12.2	14.3	16.2	18.6	21.2	23.9	26.9
1440		12.5	17.7	22.5	28.3	34.6	41.1	48.2	54.6	62.9	71.4	80.6	90.8



# AR-1400-4

Sound level are base on 1440 RPM Speed

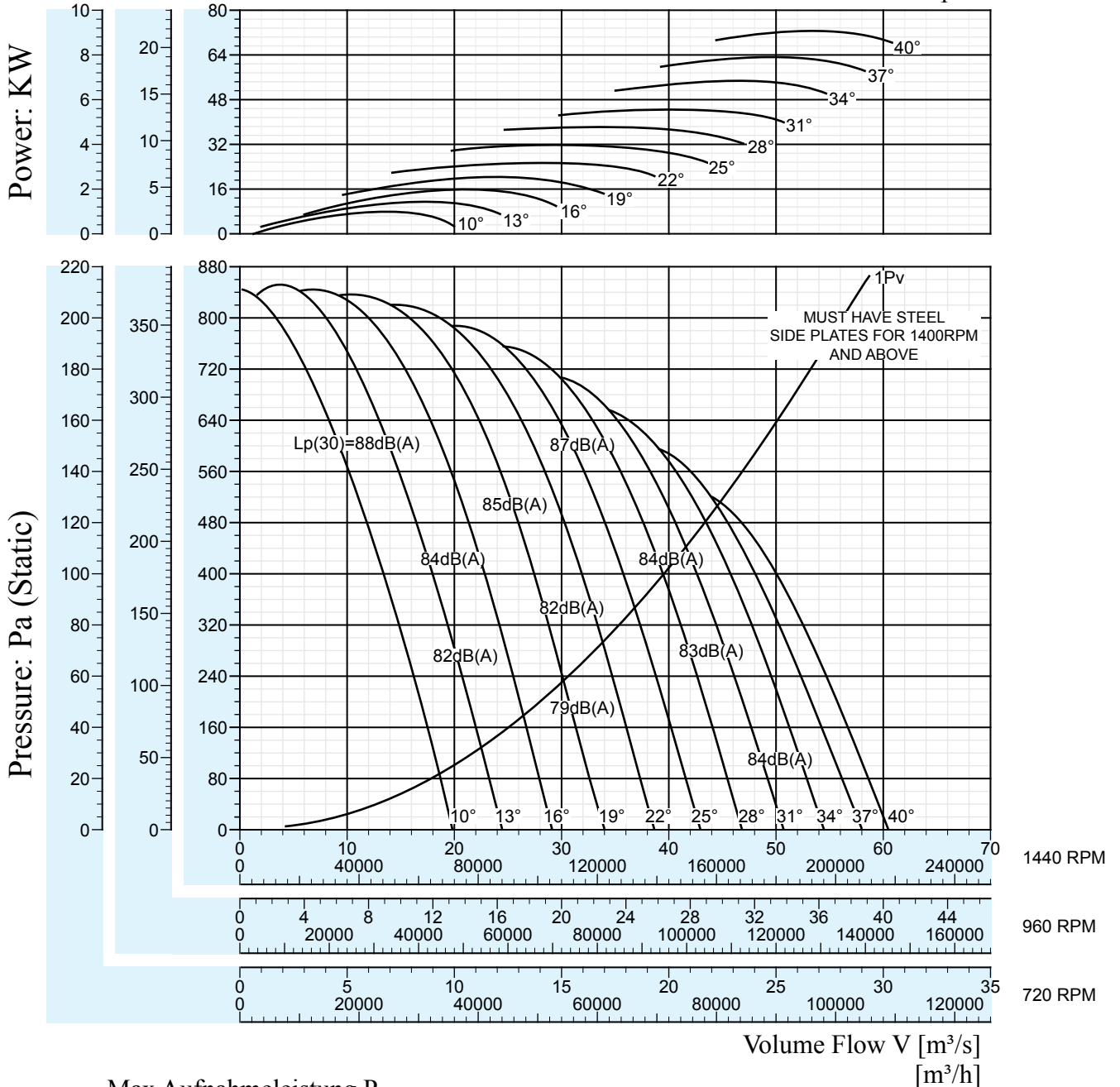

Max Aufnahmeleistung  $P_{L,max}$   
Peak absorbed power [KW]

Speed RPM	Pitch Angle	10°	13°	16°	19°	22°	25°	28°	31°	34°	37°	40°
720	Peak KW	1.00	1.46	1.98	2.52	3.22	4.01	4.84	5.63	6.81	7.86	9.02
960		2.38	3.45	4.68	5.98	7.62	9.51	11.5	13.4	16.1	18.6	21.4
1440		8.03	11.7	15.8	20.2	25.7	32.1	38.7	45.1	54.5	62.9	72.1

# AR-1400-7

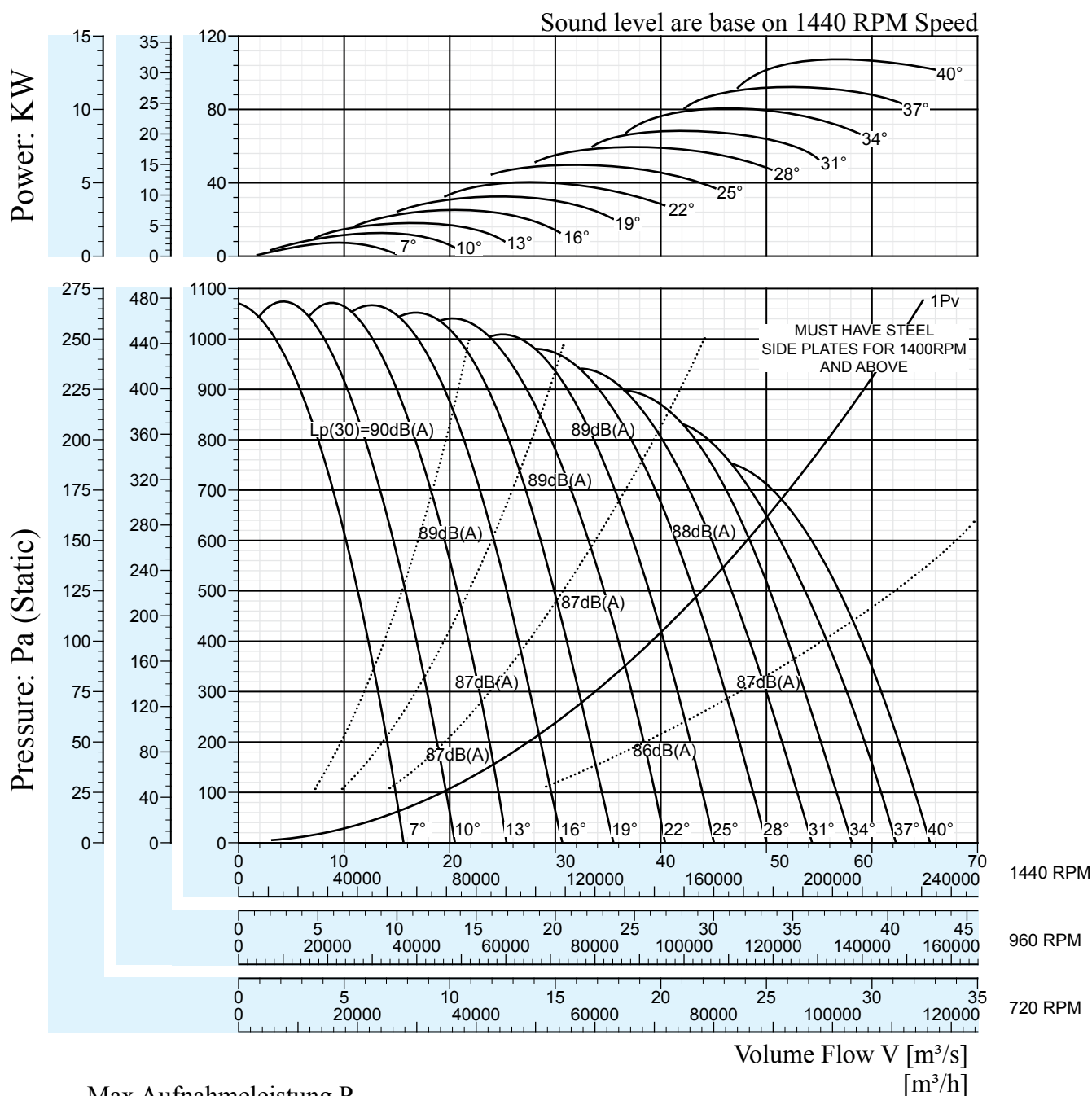

Max Aufnahmeleistung  $P_{Lmax}$   
Peak absorbed power [KW]

Speed RPM	Pitch Angle	7°	10°	13°	16°	19°	22°	25°	28°	31°	34°	37°	40°
720	Peak KW	1.11	1.75	2.41	3.17	4.15	5.08	6.26	7.46	8.54	9.98	11.4	13.3
960		2.26	4.16	5.72	7.52	9.84	12.1	14.8	17.7	20.2	23.7	27.1	31.4
1440		8.85	14.0	19.3	25.4	33.2	40.7	50.1	59.7	68.3	79.9	91.3	106

# AR-1400-11

Sound level are base on 1440 RPM Speed

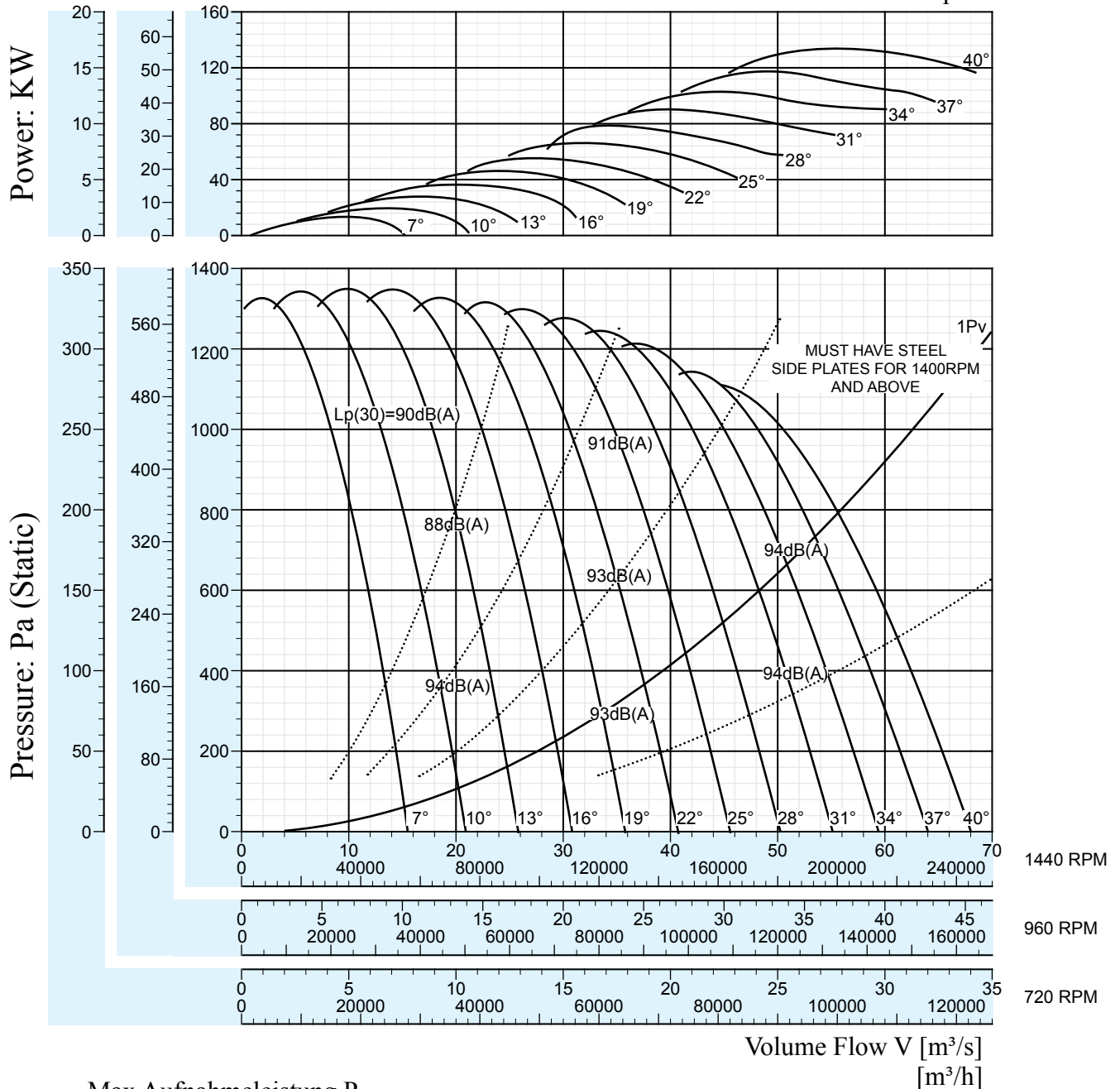

# AR-1530-4

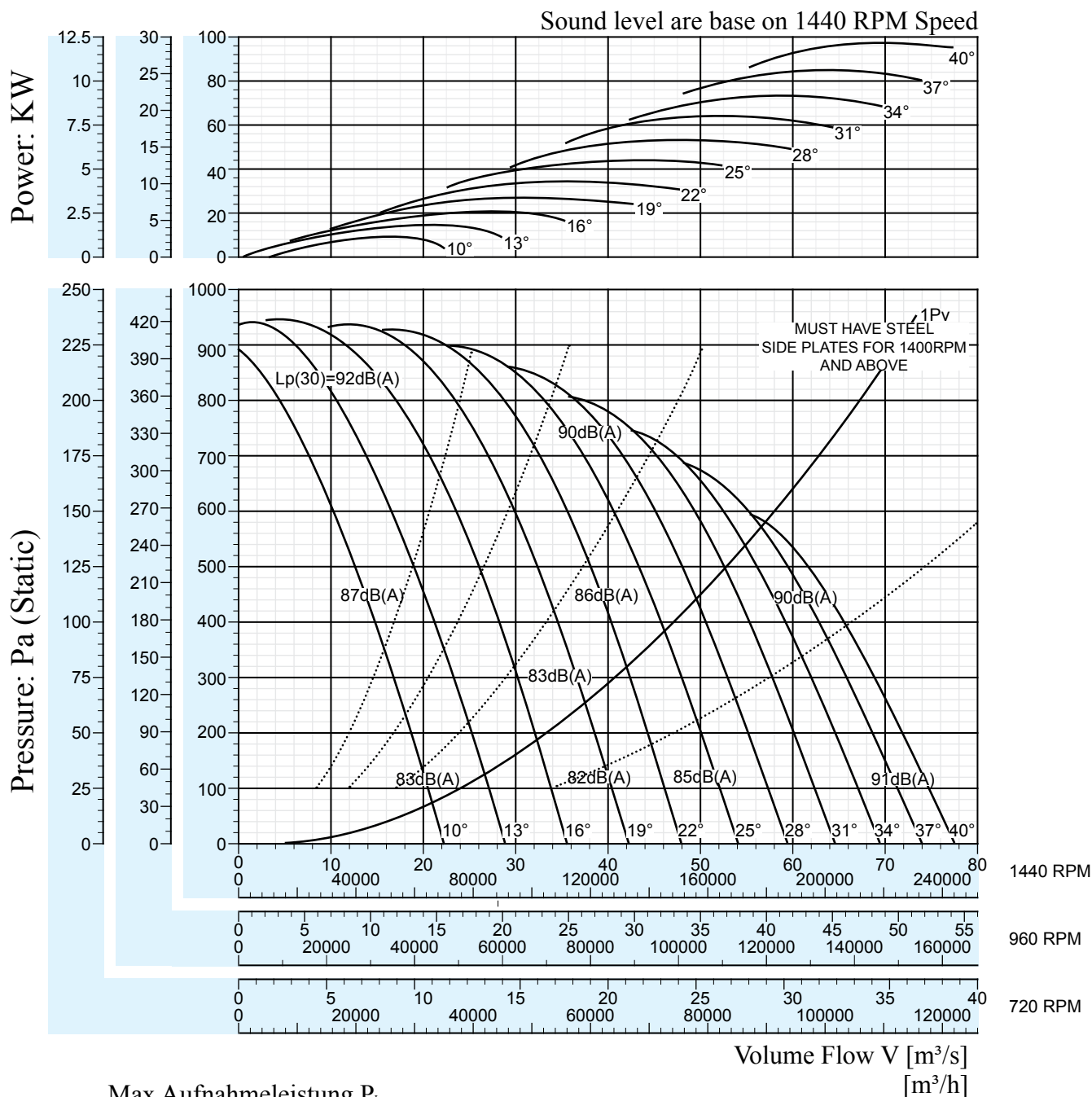

Max Aufnahmeleistung  $P_{L,max}$   
Peak absorbed power [KW]

Speed RPM	Pitch Angle	10°	13°	16°	19°	22°	25°	28°	31°	34°	37°	40°
720	Peak KW	1.16	1.79	2.51	3.34	4.28	5.38	6.52	7.82	8.93	10.4	12.0
960		2.74	4.23	5.96	7.92	10.2	12.7	15.5	18.5	21.2	24.7	28.5
1440		9.26	14.3	20.1	26.7	34.3	43.0	52.2	62.5	71.4	83.5	96.0

# AR-1530-7

Sound level are base on 1440 RPM Speed

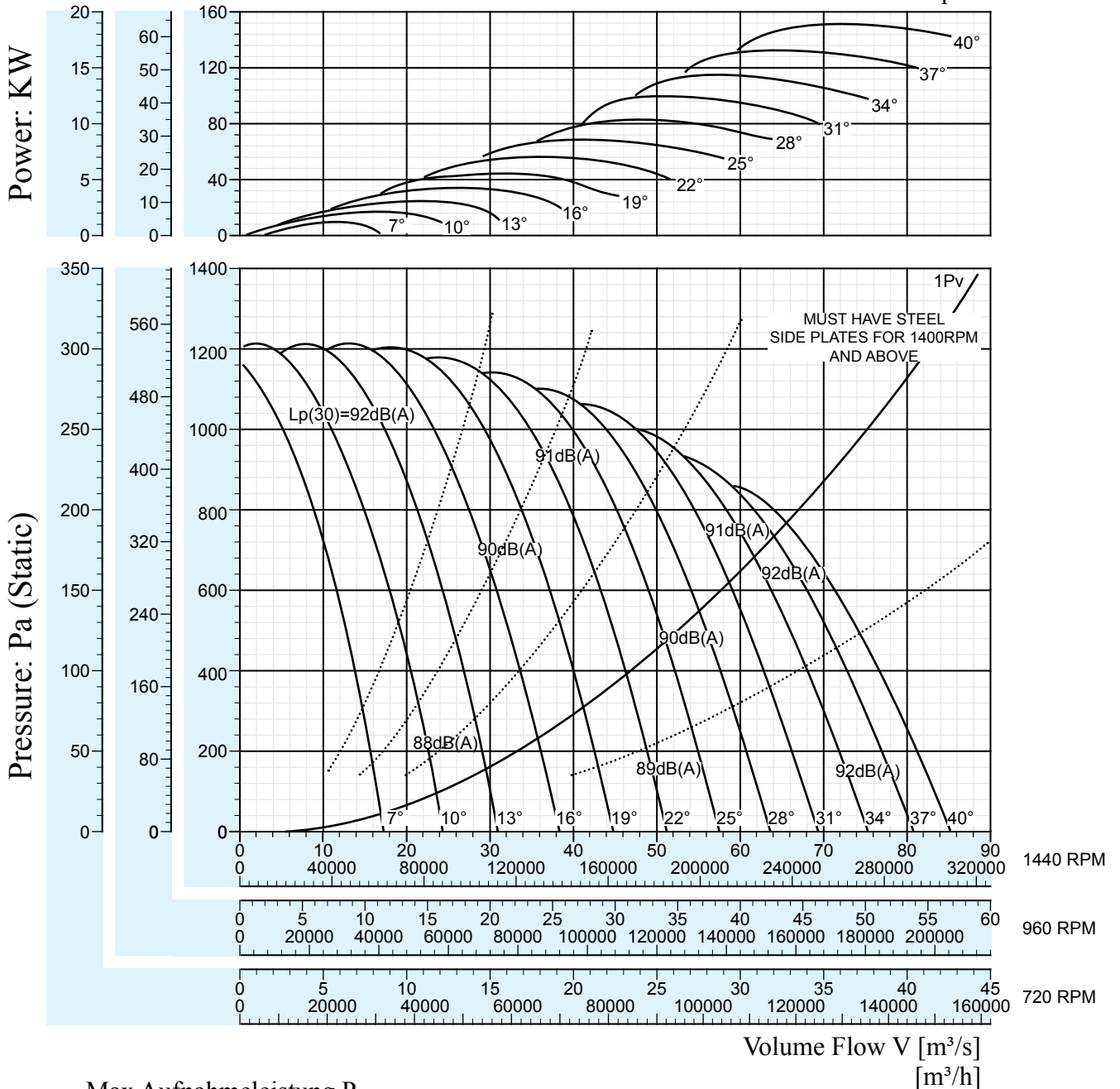

Max Aufnahmeleistung  $P_{L,max}$   
Peak absorbed power [KW]

Speed RPM	Pitch Angle	7°	10°	13°	16°	19°	22°	25°	28°	31°	34°	37°	40°
720	Peak KW	1.28	2.14	2.94	4.07	5.46	6.90	8.50	10.2	12.1	14.2	16.2	18.7
960		3.03	5.06	6.97	9.64	12.9	16.3	20.1	24.1	28.7	33.6	38.5	44.2
1440		10.2	17.1	23.5	32.5	43.7	55.2	68.0	81.2	96.9	113	130	149

# AR-1530-11

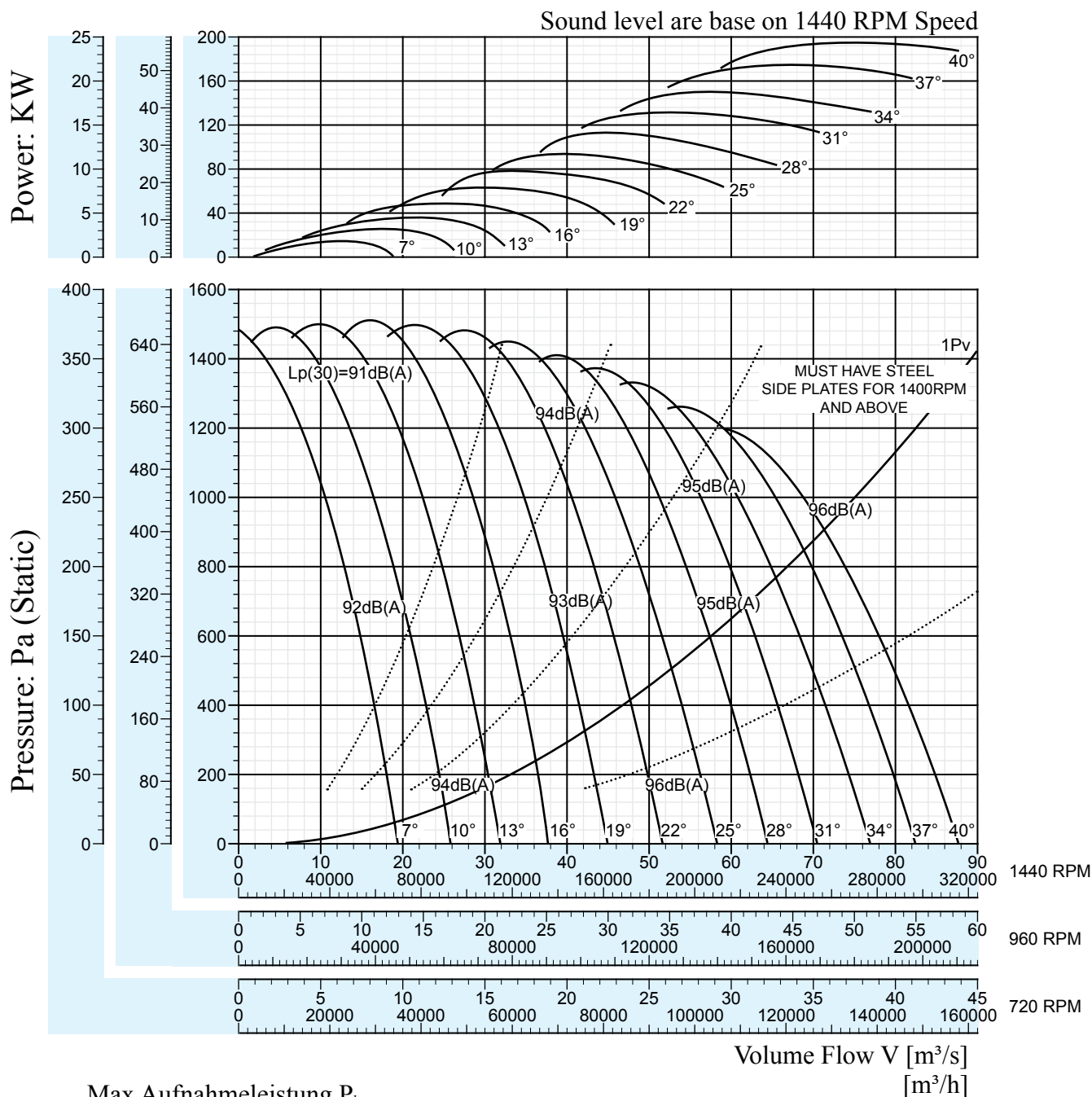

Max Aufnahmeleistung  $P_{Lmax}$   
Peak absorbed power [KW]

Speed RPM	Pitch Angle	7°	10°	13°	16°	19°	22°	25°	28°	31°	34°	37°	40°
720	Peak KW	1.94	3.16	4.23	5.79	7.50	9.57	11.3	13.6	15.9	18.2	21.2	23.9
960		4.59	7.49	10.0	13.7	17.8	22.7	26.9	32.3	37.8	43.2	50.2	56.7
1440		15.5	25.3	33.9	46.3	60.0	76.5	90.7	109	128	146	169	191

# AR-1600-4

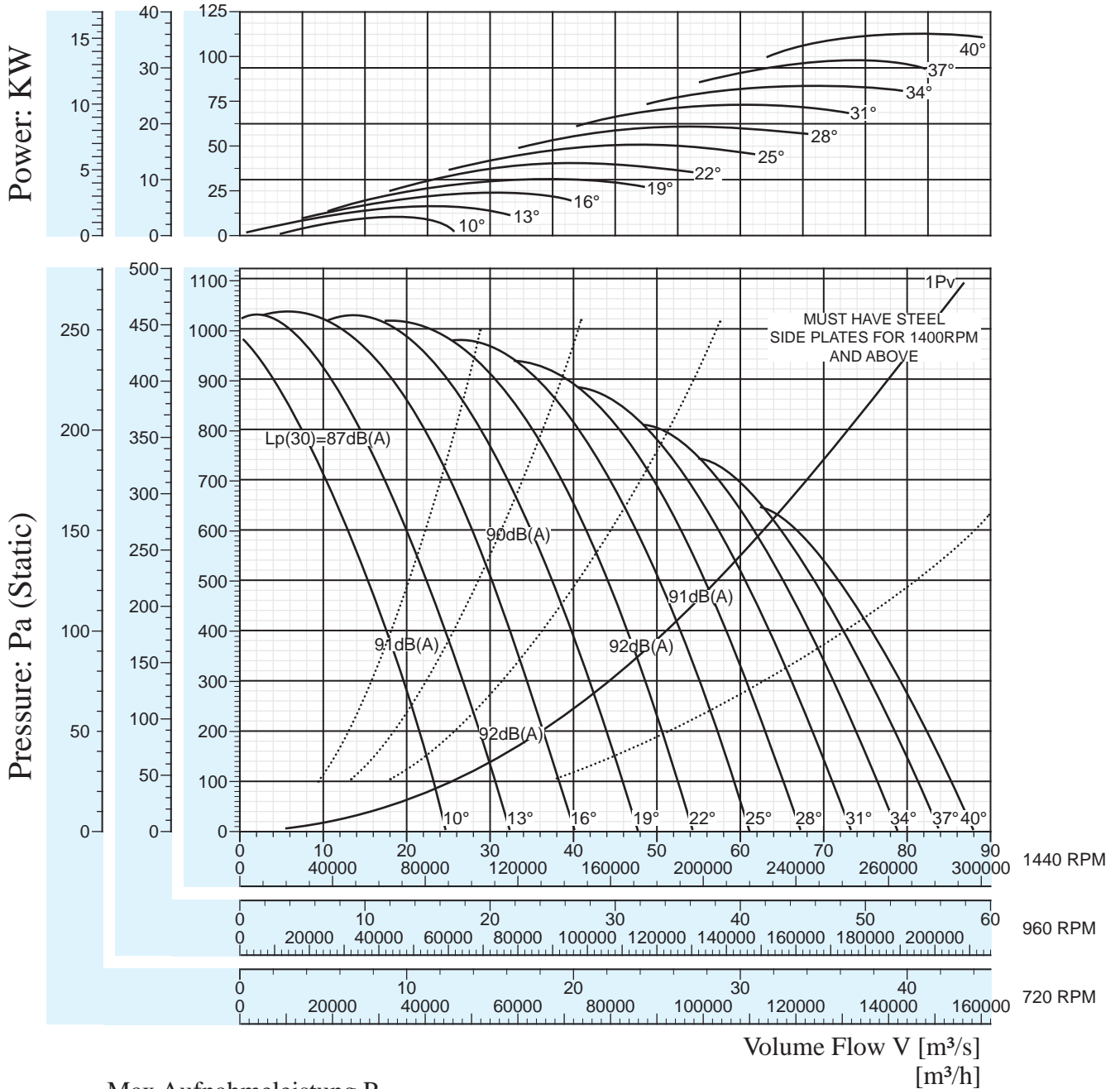

Max Aufnahmeleistung  $P_{L,max}$   
Peak absorbed power [KW]

Speed RPM	Pitch Angle	10°	13°	16°	19°	22°	25°	28°	31°	34°	37°	40°
720	Peak KW	1.45	2.24	3.14	4.18	5.25	6.73	8.16	9.78	11.6	13	15
960		3.43	5.29	7.45	9.90	12.7	15.9	19.3	23.2	26.5	30.9	35.6
1440		11.6	17.9	25.1	33.4	42.9	53.8	65.3	78.2	89.3	104	120



# AR-1600-7

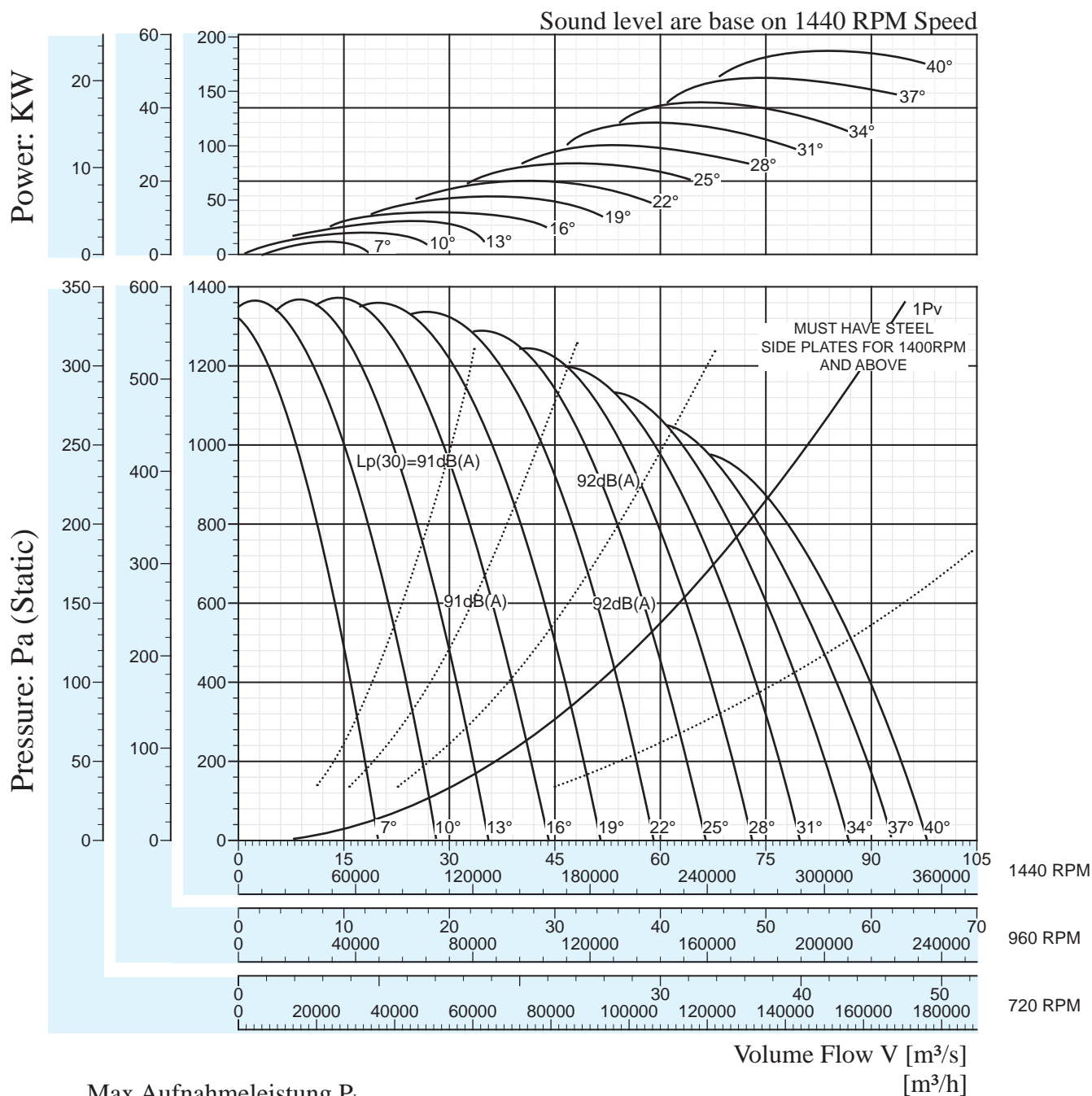

Max Aufnahmeleistung  $P_{Lmax}$   
Peak absorbed power [KW]

Speed RPM	Pitch Angle	7°	10°	13°	16°	19°	22°	25°	28°	31°	34°	37°	40°
720	Peak KW	1.6	2.68	3.68	5.09	6.83	8.63	10.63	12.75	15.13	17.75	20.38	23.38
960		3.79	6.33	8.72	12.1	16.2	20.4	25.2	30.1	35.9	42.0	48.2	55.3
1440		12.8	21.4	29.4	40.7	54.6	69.0	85.0	102	121	142	163	187

# AR-1600-11

Sound level are base on 1440 RPM Speed

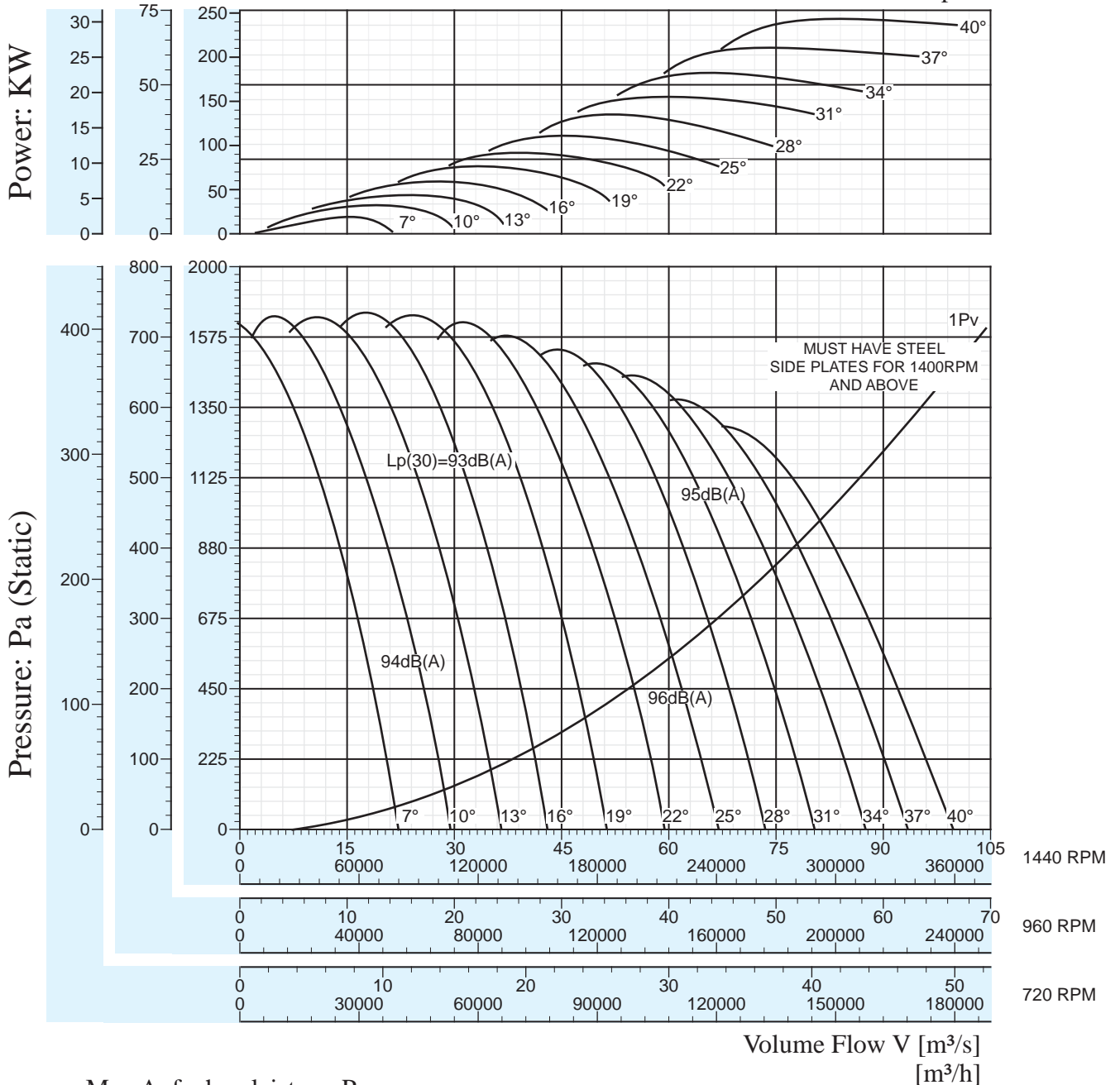

Max Aufnahmeleistung  $P_{L,max}$   
Peak absorbed power [KW]

Speed RPM	Pitch Angle	7°	10°	13°	16°	19°	22°	25°	28°	31°	34°	37°	40°
720	Peak KW	2.43	3.95	5.29	7.24	9.39	11.96	16.63	17.13	20	22.75	26.5	29.88
960		5.74	9.37	12.5	17.2	22.2	28.4	33.6	40.5	47.3	54.0	62.8	71.0
1440		19.4	31.6	42.3	57.9	75.1	95.7	113	137	160	182	212	239

Model	Speed (RPM)	Mid Frequency Hz							
		63	125	250	500	1k	2k	4k	8k
		Spectrum Factor							
AR 1000-4	720	-8	-8	-8	-9	-12	-14	-22	-30
	960	-7	-7	-7	-8	-10	-15	-20	-28
	1400	-6	-7	-7	-6	-8	-12	-19	-24
AR 1000-7	720	-6	-7	-8	-8	-11	-14	-21	-28
	960	-9	-7	-6	-7	-9	-14	-19	-26
	1400	-8	-9	-7	-5	-7	-11	-18	-22
AR 1000-11	720	-4	-5	-6	-7	-9	-12	-20	-26
	960	-9	-6	-5	-7	-8	-12	-18	-24
	1400	-9	-12	-6	-5	-7	-11	-15	-20
AR 1067-4	720	-7	-8	-8	-9	-12	-14	-22	-30
	960	-7	-7	-7	-8	-10	-15	-20	-28
	1400	-6	-7	-7	-6	-8	-12	-19	-24
AR 1067-7	720	-7	-7	-8	-8	-11	-14	-21	-28
	960	-9	-6	-6	-7	-9	-14	-19	-26
	1400	-8	-9	-7	-5	-7	-11	-18	-22
AR 1067-11	720	-5	-5	-6	-7	-9	-12	-20	-26
	960	-9	-6	-5	-7	-8	-12	-18	-24
	1400	-9	-12	-6	-5	-7	-11	-15	-20
AR 1250-4	720	-6	-8	-8	-9	-11	-14	-22	-30
	960	-6	-7	-7	-8	-10	-15	-21	-28
	1400	-6	-7	-7	-6	-9	-12	-20	-26
AR 1250-7	720	-8	-6	-8	-8	-10	-13	-21	-28
	960	-8	-5	-7	-8	-9	-14	-20	-26
	1400	-8	-8	-6	-6	-8	-12	-19	-24
AR 1250-11	720	-7	-5	-6	-7	-9	-12	-20	-26
	960	-10	-6	-5	-7	-8	-12	-18	-24
	1400	-10	-12	-6	-5	-7	-10	-15	-21
AR 1400-4	720	-6	-6	-7	-9	-11	-15	-21	-30
	960	-6	-6	-7	-8	-10	-15	-20	-29
	1400	-5	-6	-6	-7	-9	-14	-19	-27
AR 1400-7	720	-9	-7	-8	-8	-10	-13	-21	-28
	960	-8	-5	-6	-7	-9	-14	-19	-26
	1400	-7	-4	-5	-6	-8	-12	-18	-26
AR 1400-11	720	-8	-5	-6	-7	-9	-12	-20	-26
	960	-11	-6	-5	-7	-8	-12	-18	-24
	1400	-6	-7	-5	-6	-8	-10	-18	-22
AR 1530-4	720	-6	-5	-7	-8	-11	-15	-21	-32
	960	-5	-6	-6	-8	-10	-15	-19	-30
	1400	-5	-6	-6	-7	-9	-14	-19	-27
AR 1530-7	720	-9	-5	-7	-7	-10	-14	-20	-28
	960	-8	-5	-6	-7	-9	-14	-18	-27
	1400	-7	-4	-5	-6	-8	-12	-18	-26
AR 1530-11	720	-10	-5	-6	-7	-9	-12	-19	-26
	960	-12	-6	-5	-7	-8	-12	-17	-25
	1400	-6	-7	-5	-6	-8	-10	-18	-22
AR 1600-4	720	-7	-6	-8	-10	-14	-19	-22	-33
	960	-6	-7	-7	-9	-13	-18	-20	-31
AR 1600-7	720	-8	-5	-6	-7	-9	-14	-18	-27
	960	-6	-7	-5	-6	-8	-10	-18	-22
AR 1600-11	720	-12	-6	-5	-7	-8	-12	-17	-25
	960	-6	-7	-5	-6	-8	10	-18	-22

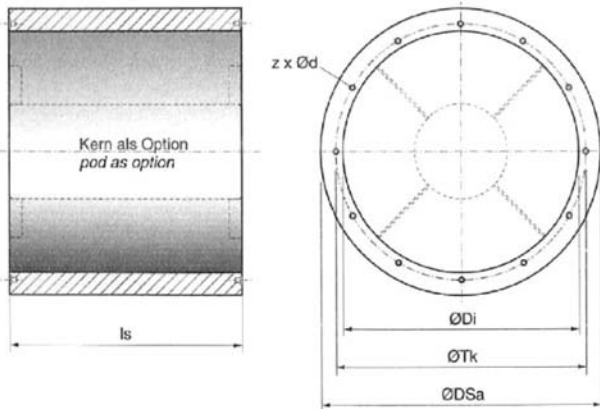

Size	Dsa mm	Di mm	Tk mm	ls 1D	z x d		Max kg			
					2D	mm	LP 1D	LP 2D	HP 1D	HP 2D
315	465	315	355	315	630	8 x 8	10	18	20	29
355	505	355	395	355	710	8 x 8	12	19	22	30
400	600	400	440	400	800	12 x 8	13	20	23	31
450	650	450	490	450	900	12 x 8	18	26	29	37
500	700	500	540	500	1000	12 x 8	23	32	35	43
560	760	560	605	560	1120	16 x 8	25	39	43	55
630	830	630	675	630	1260	16 x 8	32	43	52	64
710	910	710	755	710	1420	16 x 8	39	48	63	78
800	1000	800	845	800	1600	16 x 8	50	61	79	99
900	1100	900	945	900	1800	16 x 10	74	87	130	157
1000	1200	1000	1050	1000	2000	16 x 10	91	107	161	193
1067	1267	1067	1135	1067	2134	16 x 10	101	131	185	252
1250	1450	1250	1315	1250	2500	24 x 10	126	163	231	315
1400	1650	1400	1470	1400	2800	24 x 14	150	194	285	385

### Performance Curve

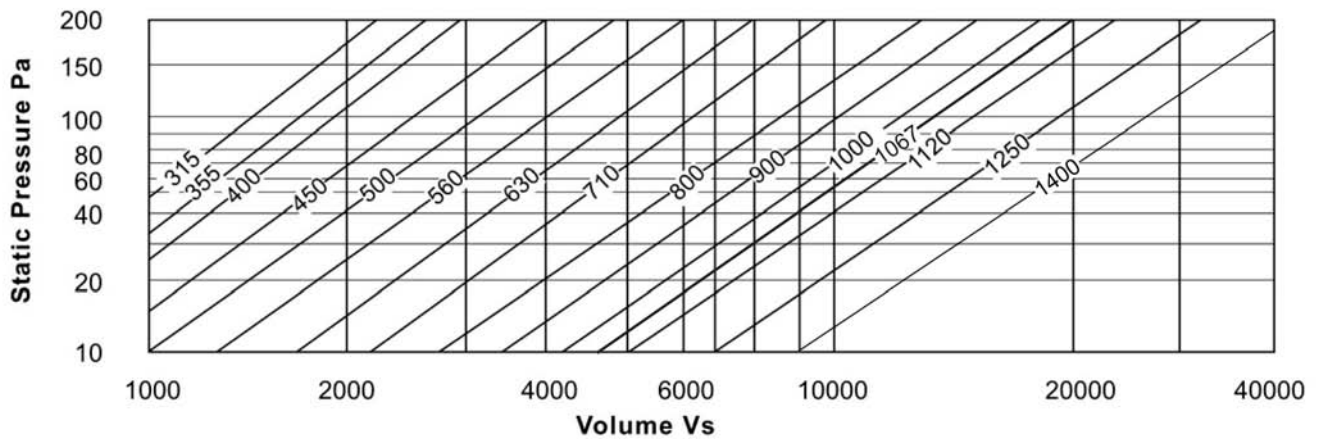

\*Note: Performance curves relate to pressure losses through HP silencers only. The LP models have negligible pressure loss.

Model	Type	Insertion Loss at Hz							
		63	125	250	500	1K	2K	4K	8K
LP 315/355/400/450/500/560	1D	1	4	7	10	14	11	8	8
HP 315/355/400/450/500/560	1D (Kern/Pod)	4	6	9	13	19	19	16	14
LP 315/355/400/450/500/560	2D	4	8	12	17	23	17	13	12
HP 315/355/400/450/500/560	2D (Kern/Pod)	7	11	15	24	28	28	26	22
LP 630/710/800/900	1D	3	5	9	14	14	9	8	7
HP 630/710/800/900	1D (Kern/Pod)	4	6	10	17	23	21	19	11
LP 630/710/800/900	2D	6	8	14	23	24	14	13	10
HP 630/710/800/900	2D (Kern/Pod)	7	11	16	29	34	32	30	19
LP 1000/1067/1250	1D	3	5	10	14	13	8	7	7
HP 1000/1067/1250	1D (Kern/Pod)	4	6	12	20	19	15	14	12
LP 1000/1067/1250	2D	6	9	14	21	20	13	11	10
HP 1000/1067/1250	2D (Kern/Pod)	7	12	19	29	28	26	22	17
HP 1400/1067/1250	1D (Kern/Pod)	4	7	14	24	20	13	8	6

\*Note: For sizes 1400 and above, please contact nearest Lti representative for selection



**LTI Ventilatoren (Asia) Pte Ltd**

19 Jalan Mesin

Singapore 368818

Tel: +65 6564 6678

Fax: +65 6564 6616

E-Mail: [sales@lti.com.sg](mailto:sales@lti.com.sg)